



MOLDINO

The Edge To Innovation

MMC Hitachi Tool Engineering Europe GmbH

EDT-TH *Epoch Direct Thread Mill*

Thread Milling with or without pilot hole



- **Multi-Material Use** $\leq 66\text{HRC}$
- **Fine Pitch possible**
- **Chamfering possible**

- **M2 - M20**
 $l_n 2.5 \times D_{Nom}$
- **M3 - M12**
 $l_n 5 \times D_{Nom}$
- **G1/16 - G1**



www.mmc-hitachitool-eu.com

EDT-TH | Epoch Direct Thread Mill TH | $l_n 2.5 \times D_{Nom}$

HRC	No. of Teeth		
66	4		Counter Clockwise (left rotation)

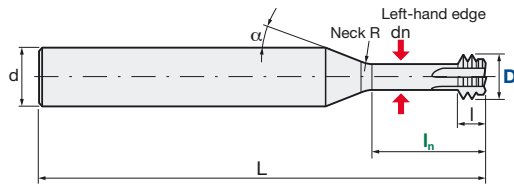

Carbide	TH60+
Micro Grain	Nano-PVD Coating



ID Code	Item Code	Regular Thread	Z	Size (mm)							L	d	Neck R	α	Inner coolant
				D	Pitch	l_n	l	dn							
EP1595	EDT-0.4-5-TH	M2	4	1.4	0.4	5	1.2	0.91	50	6	1	25°	-		
EP1596	EDT-0.45-6.25-TH	M2.5		1.8	0.45	6.25	1.35	1.24							
EP1597	EDT-0.5-7.5-TH	M3		2.4	0.5	7.5	1.5	1.78							
EP1598	EDT-0.7-10-TH	M4		3.1	0.7	10	2.1	2.24							
EP1600	EDT-0.8-12.5-TH	M5		3.8	0.8	12.5	2.4	2.8							
EP1601	EDT-1.0-15-TH	M6		4.6	1.0	15	3	3.36							
EP1603	EDT-1.25-20-TH	M8		6.2	1.25	20	3.75	4.64	70	10	2	25°	-		
EP1599	EDT-0.75-20-TH	*			0.75		2.25	5.16							
EP1604	EDT-1.5-25-TH	M10		7.5	1.5	25	4.5	5.61	80	12	-	20°	•		
EP1602	EDT-1.0-25-TH	*			1.0		3	6.11							
EP1605	EDT-1.75-30-TH	M12		9.0	1.75	30	5.25	6.78	100	16	-	20°	•		
EP1606	EDT-2-40-TH	M16		11.5	2.0	40	6	8.87	135	16	-	20°	•		
EP1810	EDT-2.5-50-TH	M20		15	2.5	51	7.5	11.71	135	16	-	20°	•		

* is only for fine pitch type thread

EDT-TH | Epoch Direct Thread Mill TH | $l_n 5 \times D_{Nom}$

Carbide	TH60+
Micro Grain	Nano-PVD Coating

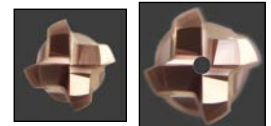

ID Code	Item Code	Regular Thread	Z	Size (mm)							L	d	Neck R	α	Inner coolant
				D	Pitch	l_n	l	dn							
EP1803	EDT-0.5-15-TH	M3 long	4	2.4	0.5	15.5	1.5	1.78	60	6	1	25°	-		
EP1804	EDT-0.7-20-TH	M4 long		3.1	0.7	21	2.1	2.24							
EP1805	EDT-0.8-25-TH	M5 long		3.8	0.8	26	2.4	2.80	70	10	2	25°	-		
EP1806	EDT-1.0-30-TH	M6 long		4.6	1	31	3	3.36							
EP1807	EDT-1.25-40-TH	M8 long		6.2	1.25	41	3.75	4.64	110	10	2	25°	•		
EP1808	EDT-1.5-50-TH	M10 Long		7.5	1.5	51	4.5	5.61							
EP1809	EDT-1.75-60-TH	M12 Long		9	1.75	61	5.25	6.78	135	16	-	20°	•		

EDT-TH | Epoch Direct Thread Mill TH | G-Type (ISO 228-1)

Carbide	TH60+
Micro Grain	Nano-PVD Coating



ID Code	Item Code	Regular Thread	Z	Size (mm)							L	d	Neck R	α	Inner coolant
				D	Pitch	l_n	l	dn							
EP1811	EDT-G1/16-18-ATH	G 1/16	4	5.8	0.9071	18	2.721	4.31	70	6	1	20°	-		
EP1812	EDT-G1/8-19-ATH	G 1/8		7.3	0.9071	19	2.721	5.81	80	10	2				
EP1813	EDT-G1/4-28-ATH	G 1/4		9.8	1.3368	28	4.011	7.59							
EP1814	EDT-G3/8-28-ATH	G 3/8		11.8	1.3368	28	4.011	9.60	110	12	-				
EP1815	EDT-G1/2-35-ATH	G 1/2		15.7	1.8143	35	5.443	12.75	135	16	-				
EP1816	EDT-G1-45-ATH	G 1		15.8	2.3091	45	6.927	12.16	135	16	-				

EDT-TH | Epoch Direct Thread Mill TH

ATH (Advanced TH) Coating – Characteristics

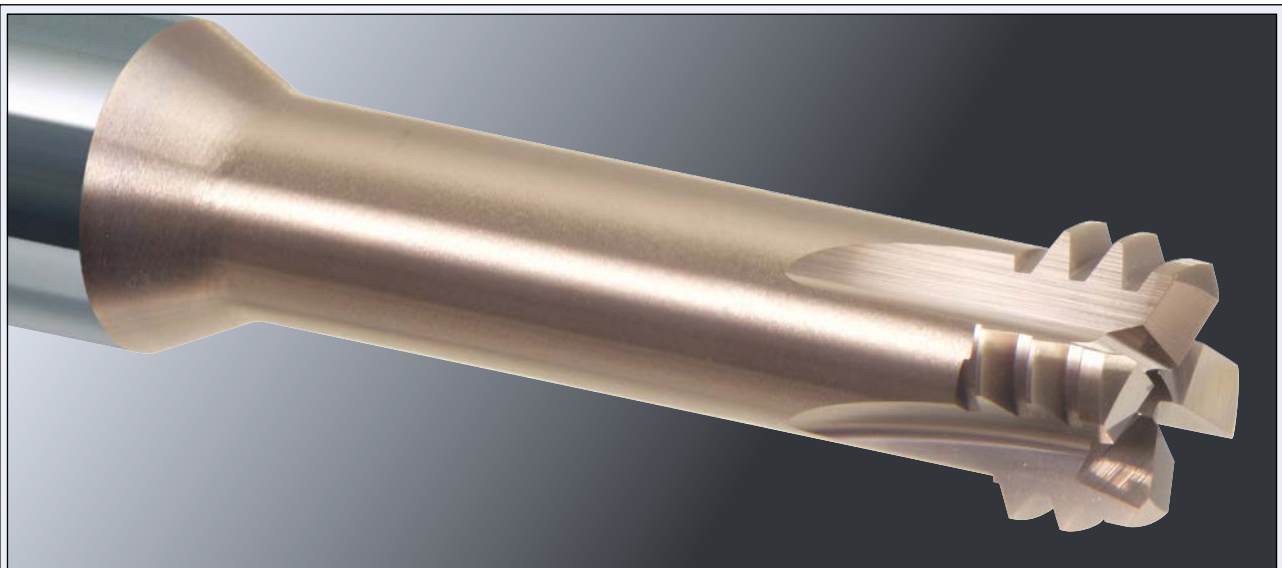
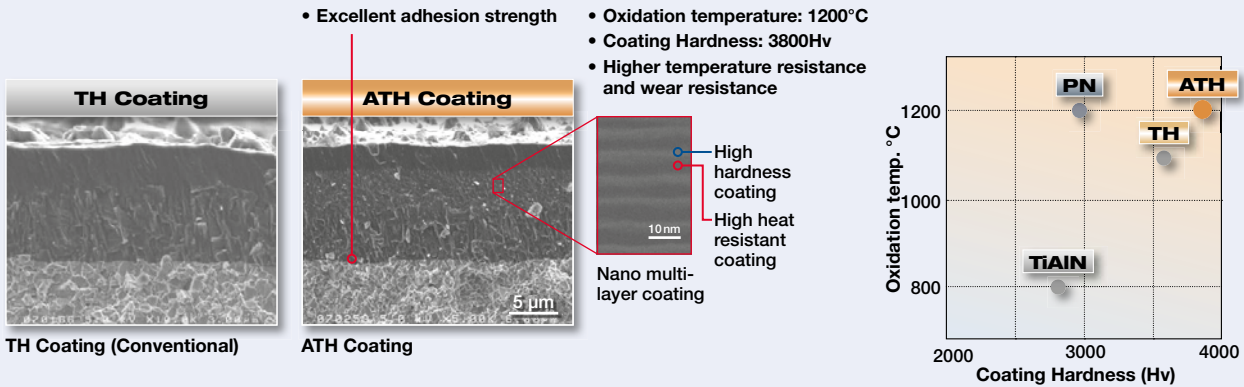

Optimized EDT cutting edges for thread milling

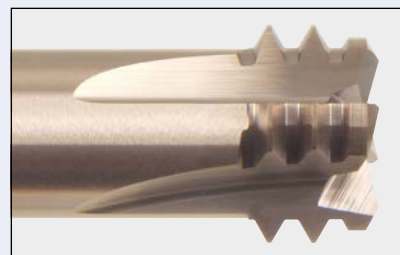
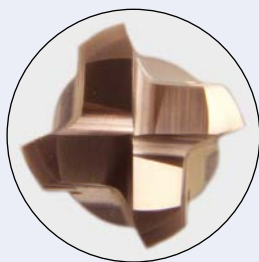

End cutting edges

- Threading without the need for initial core hole.
- If core hole already exists EDT achieves final size hole without the need for several cuts.
- When core hole already exists EDT works without the need for exact core hole diameter.

Thread cutting edges

- Strong cutting edges reduce the risk of chipping.
- Minimizes the cutting edge wear and guarantees the correct size of thread.

Cutting Conditions | Schnittwerte | Condizioni di taglio | Condiciones de Corte | Conditions de coupe | Valores de corte:

Cutting Conditions without Pilot Hole	2.5xD: Page 6	Cutting Conditions with Pilot Hole	2.5xD: Page 7
	5xD: Page 8		5xD: Page 9
		G-Type: Page 10	

EDT-TH | Epoch Direct Thread Mill TH
 **Usage of EDT**
NEVER FORGET COUNTER CLOCKWISE ROTATION (M4)!

* Please use the circle inside of your machine controller or define the tool path as shown in the graphic

1. Start point, centre of hole
2. Move to helical starting position.
3. Ramp down with helical path.
4. Produce thread with helical path.
5. Move to centre of hole after required depth.
6. Return to start point.

 **Anwendung des EDT**
ACHTUNG: BITTE STELLEN SIE DEN LINKSLAUF (M4) DER SPINDEL SICHER – EDT IST EIN LINKS-SCHNEIDENDES WERKZEUG!

* Bitte benutzen Sie den vordefinierten Zyklus Ihrer Maschinensteuerung, oder definieren Sie den Werkzeugpfad wie in der Grafik beschrieben:

1. Startposition, Zentrum der Bohrung
2. An Startposition für das Helikalfräsen annähern
3. Anfahren mit helikaler Rotation
4. Gewindeschneiden mit helikaler Rotation
5. Nach Fertigstellung des Gewindes den Fräser mit helikaler Rotation ins Zentrum der Bohrung zurückführen.
6. Fräser zurück an Startposition bewegen

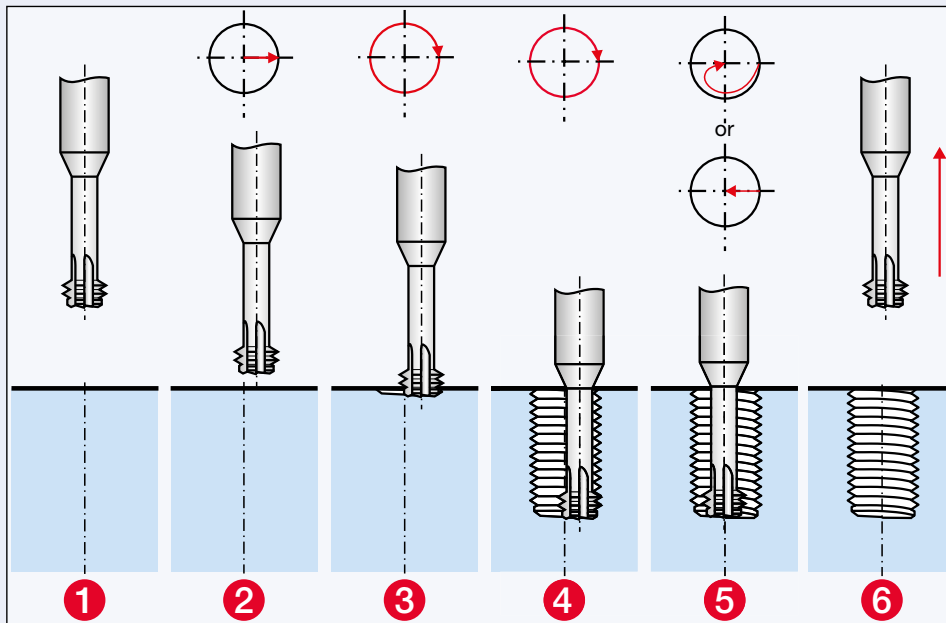
 **Utilizzo EDT**
ATTENZIONE. LA ROTAZIONE DEL MANDRINO DEVE ESSERE SINISTRORSA (M4)!

* utilizzare il cerchio all'interno del vostro controllo numerico o definire il percorso utensile come mostrato del grafico

1. Punto iniziale
2. Raggiungere il punto di inizio del percorso elicoidale
3. Approccio sul profilo con percorso elicoidale
4. Fresatura del filetto con percorso elicoidale
5. Ritorno graduale nel centro del foro una volta conclusa la fresatura del filetto
6. Ritorno della fresa sul punto iniziale

 **Uso de EDT**
NO OLVIDE ROTACION DEL CABEZAL A IZQUIERDAS (M4)!

* Por favor, use el círculo interno del control de su máquina o defina la trayectoria de la herramienta, como se muestra en el gráfico.

1. Punto de inicio
2. Llegue a la posición del inicio helicoidal
3. Baje con trayectoria helicoidal
4. Rosque con trayectoria helicoidal
5. Movimiento mecanizando gradualmente hacia el centro con trayectoria helicoidal después del acabado del roscado
6. Levante al punto de inicio

 **Utilisation de l'EDT**
NE JAMAIS OUBLIER LA ROTATION BROCHE ANTIHORAIRE (M4) !

* Veuillez utiliser le cycle prédéfini de la commande Numérique de votre machine ou créez un parcours tel qu'illustré dans le graphique.

1. Point de départ
2. Déplacement vers le point de départ de l'interpolation hélicoïdale
3. Approche verticale hélicoïdale
4. Filetage en interpolation hélicoïdale
5. Dégagement en rayon de la fraise vers le centre du trou, une fois le filetage terminé
6. Dégagement de la fraise vers le point de départ

 **Uso da EDT**
NUNCA ESQUECER, ROTAÇÃO DO EIXO DA ÁRVORE À ESQUERDA! (M4)!

* Utilize o círculo do seu controlador da máquina ou defina o caminho da ferramenta conforme apresentado no gráfico.

1. Ponto inicial
2. Vá para a posição de partida helicoidal
3. Aproxime-se para baixo com o trajeto helicoidal
4. Com o trajeto helicoidal
5. Mova gradualmente a fresa para o centro do furo com o trajeto helicoidal, depois de ter terminado.
6. Levante a fresa para o ponto inicial.

EDT-TH | Epoch Direct Thread Mill TH

Point 1: Feed rate set up

V_f (Feed rate of peripheral edges)

$$V_f (\text{Center}) = f_z \times z \times n \times (D1 - Dc) / D1$$

V_f (peripheral)

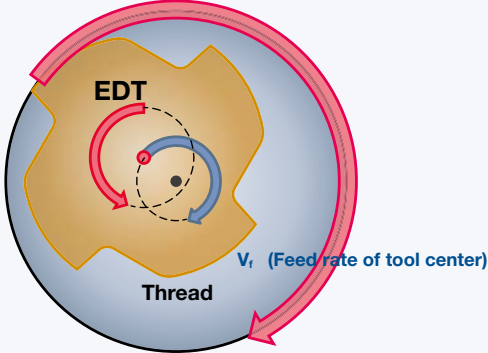

- V_f : Feed rate of tool center (mm/min)
- f_z : Feed rate per tooth (mm/t)
- z : cutting edges number
- n : rotation (min⁻¹)
- $D1$: thread diameter (mm)
- Dc : tool diameter (mm)

Please be careful of feed rate set-up in program.

Point 2: Compensation

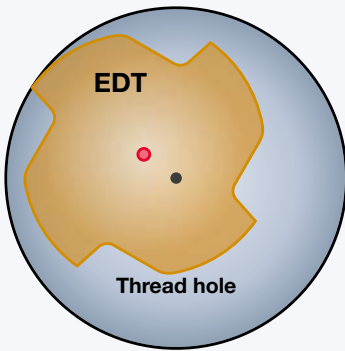

Theoretical situation

Difference d is probably caused by deflection or reduced diameter of tool, therefore smaller threads will be reduced.

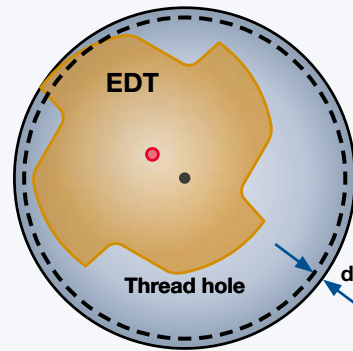

Possible situation

Compensation or spring cut could be helpful to reach the requested thread size.

Point 3: Chip evacuation

Good

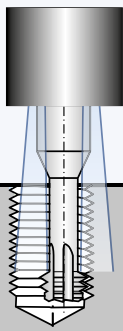

OK

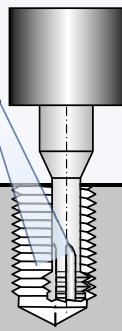

No!

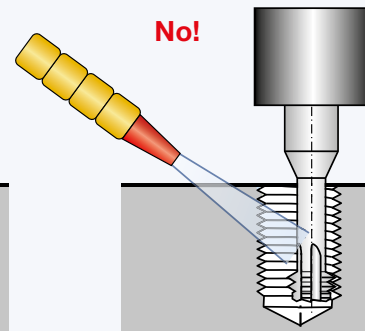

Chip evacuation is very important!



EDT-TH | Cutting Condition without Pilot Hole

$I_n 2.5 \times D_{Nom}$

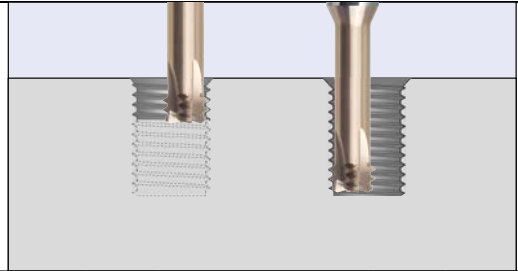

Standard without Pilot Hole (2.5 x D)													
Material group	Cutting Parameter	Thread	M2	M25	M3	M4	M5	M6	M8	M10	M12	M16	M20
		Pitch	0.4	0.5	0.5	0.7	0.8	1.0	1.25	1.5	1.75	2.0	2.5
		D mm	1.4	1.8	2.4	3.1	3.8	4.6	6.2	7.5	9	11.5	15.0
Pre-hardened steel (25–35HRC)	V_c	m/min	65	65	65	65	65	65	65	65	65	65	65
	n	min ⁻¹	14800	11500	8600	6700	5400	4500	3300	2800	2300	1800	1400
	f_z	mm/tooth	0.0057	0.0076	0.0105	0.0143	0.0171	0.0219	0.0295	0.0361	0.0428	0.0523	0.0665
	V_f (peripheral)	mm	340	350	360	380	370	390	390	400	390	380	370
Tool Steels (35–45HRC)	V_c	m/min	55	55	55	55	55	55	55	55	55	55	55
	n	min ⁻¹	12500	9700	7300	5700	4600	3800	2800	2300	1900	1500	1200
	f_z	mm/tooth	0.0054	0.0072	0.0099	0.0135	0.0162	0.0207	0.0279	0.0342	0.0405	0.0495	0.0630
	V_f (peripheral)	mm	270	280	290	310	300	310	310	310	310	300	300
Tool Steels (46–55HRC)	V_c	m/min	45	45	45	45	45	45	45	45	45	45	45
	n	min ⁻¹	10200	8000	6000	4600	3800	3100	2300	1900	1600	1200	1000
	f_z	mm/tooth	0.0051	0.0068	0.0094	0.0128	0.0153	0.0196	0.0264	0.0323	0.0383	0.0468	0.0595
	V_f (peripheral)	mm	210	220	220	230	230	240	240	250	240	220	240
Hardened Steel (56–62HRC)	V_c	m/min	35	35	35	35	35	35	35	35	35	35	35
	n	min ⁻¹	8000	6200	4600	3600	2900	2400	1800	1500	1200	1000	700
	f_z	mm/tooth	0.0045	0.0060	0.0083	0.0113	0.0135	0.0173	0.0233	0.0285	0.0338	0.0413	0.0525
	V_f (peripheral)	mm	140	150	150	160	160	170	170	170	160	170	150
Hardened Steel and High speed steel (63–66HRC)	V_c	m/min	25	25	25	25	25	25	25	25	25	25	25
	n	min ⁻¹	5700	4400	3300	2600	2100	1700	1300	1100	900	700	500
	f_z	mm/tooth	0.0039	0.0052	0.0072	0.0098	0.0117	0.0150	0.0202	0.0247	0.0293	0.0358	0.0455
	V_f (peripheral)	mm	90	90	90	100	100	100	100	110	110	100	90
Stainless Steel, Titan alloy (25–35HRC)	V_c	m/min	35	35	35	35	35	35	35	35	35	35	35
	n	min ⁻¹	8000	6200	4600	3600	2900	2400	1800	1500	1200	1000	700
	f_z	mm/tooth	0.0048	0.0064	0.0088	0.0120	0.0144	0.0184	0.0248	0.0304	0.0360	0.0440	0.0560
	V_f (peripheral)	mm	150	160	160	170	170	180	180	180	170	180	160
Alumium alloy, Copper alloy Carbon Steels, Alloy Steels Cast Irons EN-JL(GG), EN-JS (GGG) (-300HB)	V_c	m/min	70	70	70	70	70	70	70	70	70	70	70
	n	min ⁻¹	15900	12400	9300	7200	5900	4800	3600	3000	2500	1900	1500
	f_z	mm/tooth	0.0060	0.0080	0.0110	0.0150	0.0180	0.0230	0.0310	0.0380	0.0450	0.0550	0.0700
	V_f (peripheral)	mm	380	400	410	430	420	440	450	460	450	420	420

Efficient without Pilot Hole (2.5 x D)													
Material group	Cutting Parameter	Thread	M2	M25	M3	M4	M5	M6	M8	M10	M12	M16	M20
		Pitch	0.4	0.5	0.5	0.7	0.8	1.0	1.25	1.5	1.75	2.0	2.5
		D mm	1.4	1.8	2.4	3.1	3.8	4.6	6.2	7.5	9	11.5	15.0
Pre-hardened steel (25–35HRC)	V_c	m/min	75	75	75	75	75	75	75	75	75	75	75
	n	min ⁻¹	17100	13300	10000	7700	6300	5200	3900	3200	2700	2100	1600
	f_z	mm/tooth	0.0058	0.0078	0.0107	0.0146	0.0175	0.0223	0.0301	0.0369	0.0437	0.0534	0.0679
	V_f (peripheral)	mm	400	410	430	450	440	460	470	470	470	450	430
Tool Steels (35–45HRC)	V_c	m/min	65	65	65	65	65	65	65	65	65	65	65
	n	min ⁻¹	14800	11500	8600	6700	5400	4500	3300	2800	2300	1800	1400
	f_z	mm/tooth	0.0056	0.0074	0.0102	0.0140	0.0167	0.0214	0.0288	0.0353	0.0419	0.0512	0.0651
	V_f (peripheral)	mm	330	340	350	370	360	390	380	400	390	370	360
Tool Steels (46–55HRC)	V_c	m/min	55	55	55	55	55	55	55	55	55	55	55
	n	min ⁻¹	12500	9700	7300	5700	4600	3800	2800	2300	1900	1500	1200
	f_z	mm/tooth	0.0053	0.0070	0.0097	0.0132	0.0158	0.0202	0.0273	0.0334	0.0396	0.0484	0.0616
	V_f (peripheral)	mm	260	270	280	300	290	310	310	310	300	290	300
Hardened Steel (56–62HRC)	V_c	m/min	45	45	45	45	45	45	45	45	45	45	45
	n	min ⁻¹	10200	8000	6000	4600	3800	3100	2300	1900	1600	1200	1000
	f_z	mm/tooth	0.0048	0.0064	0.0088	0.0120	0.0144	0.0184	0.0248	0.0304	0.0360	0.0440	0.0560
	V_f (peripheral)	mm	200	200	210	220	220	230	230	230	230	210	220
Hardened Steel and High speed steel (63–66HRC)	V_c	m/min	35	35	35	35	35	35	35	35	35	35	35
	n	min ⁻¹	8000	6200	4600	3600	2900	2400	1800	1500	1200	1000	700
	f_z	mm/tooth	0.0045	0.0060	0.0083	0.0113	0.0135	0.0173	0.0233	0.0285	0.0338	0.0413	0.0525
	V_f (peripheral)	mm	140	150	150	160	160	170	170	170	160	170	150
Stainless Steel, Titan alloy (25–35HRC)	V_c	m/min	45	45	45	45	45	45	45	45	45	45	45
	n	min ⁻¹	10200	8000	6000	4600	3800	3100	2300	1900	1600	1200	1000
	f_z	mm/tooth	0.0051	0.0068	0.0094	0.0128	0.0153	0.0196	0.0264	0.0323	0.0383	0.0468	0.0595
	V_f (peripheral)	mm	210	220	220	230	230	240	240	250	240	220	240
Alumium alloy, Copper alloy Carbon Steels, Alloy Steels Cast Irons EN-JL(GG), EN-JS (GGG) (-300HB)	V_c	m/min	85	85	85	85	85	85	85	85	85	85	85
	n	min ⁻¹	19300	15000	11300	8700	7100	5900	4400	3600	3000	2400	1800
	f_z	mm/tooth	0.0060	0.0080	0.0110	0.0150	0.0180	0.0230	0.0310	0.0380	0.0450	0.0550	0.0700
	V_f (peripheral)	mm	460	480	500	520	510	540	550	550	540	530	500

Please choose the cutting condition based on Tool diameter.



EDT-TH | Cutting Condition with Pilot Hole

$I_n 2.5 \times D_{Nom}$

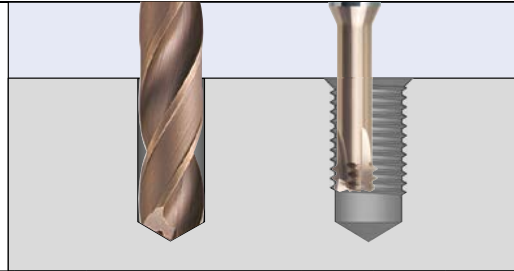

Standard with Pilot Hole (2.5 x D)													
Material group	Cutting Parameter	Thread	M2	M25	M3	M4	M5	M6	M8	M10	M12	M16	M20
		Pitch	0.4	0.5	0.5	0.7	0.8	1.0	1.25	1.5	1.75	2.0	2.5
		D mm	1.4	1.8	2.4	3.1	3.8	4.6	6.2	7.5	9	11.5	15.0
Pre-hardened steel (25–35HRC)	V_c	m/min	85	85	85	85	85	85	85	85	85	85	85
	n	min ⁻¹	19300	15000	11300	8700	7100	5900	4400	3600	3000	2400	1800
	f_z	mm/tooth	0.0060	0.0080	0.0110	0.0150	0.0180	0.0229	0.0309	0.0379	0.0449	0.0549	0.0698
	V_f (peripheral)	mm	460	480	500	520	510	540	540	550	540	530	500
Tool Steels (35–45HRC)	V_c	m/min	75	75	75	75	75	75	75	75	75	75	75
	n	min ⁻¹	17100	13300	10000	7700	6300	5200	3900	3200	2700	2100	1600
	f_z	mm/tooth	0.0057	0.0076	0.0104	0.0142	0.0170	0.0217	0.0293	0.0359	0.0425	0.0520	0.0662
	V_f (peripheral)	mm	390	400	420	440	430	450	460	460	460	440	420
Tool Steels (46–55HRC)	V_c	m/min	65	65	65	65	65	65	65	65	65	65	65
	n	min ⁻¹	14800	11500	8600	6700	5400	4500	3300	2800	2300	1800	1400
	f_z	mm/tooth	0.0054	0.0071	0.0098	0.0134	0.0161	0.0205	0.0277	0.0339	0.0402	0.0491	0.0625
	V_f (peripheral)	mm	320	330	340	360	350	370	370	380	370	350	350
Hardened Steel (56–62HRC)	V_c	m/min	55	55	55	55	55	55	55	55	55	55	55
	n	min ⁻¹	12500	9700	7300	5700	4600	3800	2800	2300	1900	1500	1200
	f_z	mm/tooth	0.0047	0.0063	0.0087	0.0118	0.0142	0.0181	0.0244	0.0299	0.0354	0.0433	0.0551
	V_f (peripheral)	mm	240	240	250	270	260	280	270	280	270	260	260
Hardened Steel and High speed steel (63–66HRC)	V_c	m/min	45	45	45	45	45	45	45	45	45	45	45
	n	min ⁻¹	10200	8000	6000	4600	3800	3100	2300	1900	1600	1200	1000
	f_z	mm/tooth	0.0041	0.0055	0.0075	0.0102	0.0123	0.0157	0.0212	0.0259	0.0307	0.0375	0.0478
	V_f (peripheral)	mm	170	170	180	190	190	190	190	200	200	180	190
Stainless Steel, Titan alloy (25–35HRC)	V_c	m/min	55	55	55	55	55	55	55	55	55	55	55
	n	min ⁻¹	12500	9700	7300	5700	4600	3800	2800	2300	1900	1500	1200
	f_z	mm/tooth	0.0050	0.0067	0.0092	0.0126	0.0151	0.0193	0.0260	0.0319	0.0378	0.0462	0.0588
	V_f (peripheral)	mm	250	260	270	290	280	290	290	290	290	280	280
Alumium alloy, Copper alloy Carbon Steels, Alloy Steels Cast Irons EN-JL(GG), EN-JS (GGG) (-300HB)	V_c	m/min	95	95	95	95	95	95	95	95	95	95	95
	n	min ⁻¹	21600	16800	12600	9800	8000	6600	4900	4000	3400	2600	2000
	f_z	mm/tooth	0.0063	0.0084	0.0116	0.0158	0.0189	0.0242	0.0326	0.0399	0.0473	0.0578	0.0735
	V_f (peripheral)	mm	540	560	580	620	600	640	640	640	640	600	590

Please choose the cutting condition based on Tool diameter.

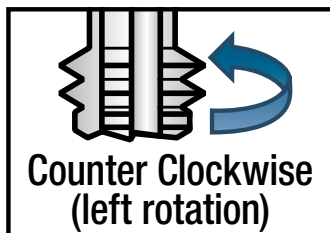

🇬🇧 NEVER forget counter clockwise rotation (M4), because EDT has left cutting edge!

🇮🇹 Attenzione: programmare la rotazione del mandrino sinistrorsa (M4), visto che le frese EDT hanno tagliente sinistro!

🇫🇷 Note : Assurez-vous d'avoir une rotation à gauche (antihoraire), l'EDT a une hélice à gauche !

🇩🇪 Achtung: Bitte stellen Sie den Linkslauf (M4) der Spindel sicher – EDT ist ein linksschneidendes Werkzeug!

🇪🇸 No olvide rotacion del cabezal a kizquierdas (M4), porque EDT tiene el filo de corte a izquierdas!

🇵🇹 Nota: Garanta rotação do eixo da árvore à esquerda porque o EDT tem arestas de corte esquerdas!



EDT-TH | Cutting Condition without Pilot Hole

$I_n 5 \times D_{Nom}$

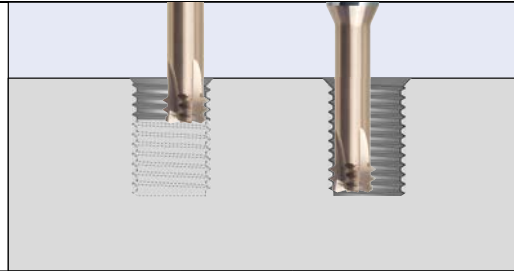

Standard without Pilot Hole (5 x D)									
Material group	Cutting Parameter	Thread	M3	M4	M5	M6	M8	M10	M12
		Pitch	0.5	0.7	0.8	1.0	1.25	1.5	1.75
		D mm	2.4	3.1	3.8	4.6	6.2	7.5	9
Pre-hardened steel (25–35HRC)	V_c	m/min	60	60	60	60	60	60	60
	n	min ⁻¹	8000	6200	5000	4200	3100	2500	2100
	f_z	mm/tooth	0.0078	0.0110	0.0135	0.0177	0.0244	0.0307	0.0363
	V_f (peripheral)	mm	250	270	270	300	300	310	310
Tool Steels (35–45HRC)	V_c	m/min	50	50	50	50	50	50	50
	n	min ⁻¹	6600	5100	4200	3500	2600	2100	1800
	f_z	mm/tooth	0.0074	0.0104	0.0128	0.0168	0.0232	0.0291	0.0344
	V_f (peripheral)	mm	200	210	220	230	240	240	250
Tool Steels (46–55HRC)	V_c	m/min	42	42	42	42	42	42	42
	n	min ⁻¹	5600	4300	3500	2900	2200	1800	1500
	f_z	mm/tooth	0.0070	0.0098	0.0121	0.0158	0.0219	0.0275	0.0325
	V_f (peripheral)	mm	160	170	170	180	190	200	200
Hardened Steel (56–62HRC)	V_c	m/min	33	33	33	33	33	33	33
	n	min ⁻¹	4400	3400	2800	2300	1700	1400	1200
	f_z	mm/tooth	0.0062	0.0087	0.0107	0.0140	0.0193	0.0242	0.0287
	V_f (peripheral)	mm	110	120	120	130	130	140	140
Hardened Steel and High speed steel (63–66HRC)	V_c	m/min	25	25	25	25	25	25	25
	n	min ⁻¹	3300	2600	2100	1700	1300	1100	900
	f_z	mm/tooth	0.0054	0.0075	0.0092	0.0121	0.0167	0.0210	0.0249
	V_f (peripheral)	mm	70	80	80	80	90	90	90
Stainless Steel, Titan alloy (25–35HRC)	V_c	m/min	33	33	33	33	33	33	33
	n	min ⁻¹	4400	3400	2800	2300	1700	1400	1200
	f_z	mm/tooth	0.0066	0.0092	0.0114	0.0149	0.0206	0.0258	0.0306
	V_f (peripheral)	mm	120	130	130	140	140	140	150
Alumium alloy, Copper alloy Carbon Steels, Alloy Steels Cast Irons EN-JL(GG), EN-JS (GGG) (-300HB)	V_c	m/min	65	65	65	65	65	65	65
	n	min ⁻¹	8600	6700	5400	4500	3300	2800	2300
	f_z	mm/tooth	0.0083	0.0116	0.0142	0.0186	0.0257	0.0323	0.0383
	V_f (peripheral)	mm	280	310	310	340	340	360	350

Efficient without Pilot Hole (5 x D)									
Material group	Cutting Parameter	Thread	M3	M4	M5	M6	M8	M10	M12
		Pitch	0.5	0.7	0.8	1.0	1.25	1.5	1.75
		D mm	2.4	3.1	3.8	4.6	6.2	7.5	9
Pre-hardened steel (25–35HRC)	V_c	m/min	70	70	70	70	70	70	70
	n	min ⁻¹	9300	7200	5900	4800	3600	3000	2500
	f_z	mm/tooth	0.0080	0.0112	0.0138	0.0181	0.0250	0.0313	0.0371
	V_f (peripheral)	mm	300	320	330	350	360	380	370
Tool Steels (35–45HRC)	V_c	m/min	62	62	62	62	62	62	62
	n	min ⁻¹	8200	6400	5200	4300	3200	2600	2200
	f_z	mm/tooth	0.0077	0.0107	0.0132	0.0173	0.0239	0.0300	0.0356
	V_f (peripheral)	mm	250	270	280	300	310	310	310
Tool Steels (46–55HRC)	V_c	m/min	55	55	55	55	55	55	55
	n	min ⁻¹	7300	5700	4600	3800	2800	2300	1900
	f_z	mm/tooth	0.0073	0.0102	0.0125	0.0164	0.0226	0.0284	0.0337
	V_f (peripheral)	mm	210	230	230	250	250	260	260
Hardened Steel (56–62HRC)	V_c	m/min	45	45	45	45	45	45	45
	n	min ⁻¹	6000	4600	3800	3100	2300	1900	1600
	f_z	mm/tooth	0.0066	0.0092	0.0114	0.0149	0.0206	0.0258	0.0306
	V_f (peripheral)	mm	160	170	170	180	190	200	200
Hardened Steel and High speed steel (63–66HRC)	V_c	m/min	35	35	35	35	35	35	35
	n	min ⁻¹	4600	3600	2900	2400	1800	1500	1200
	f_z	mm/tooth	0.0062	0.0087	0.0107	0.0140	0.0193	0.0242	0.0287
	V_f (peripheral)	mm	110	120	120	130	140	150	140
Stainless Steel, Titan alloy (25–35HRC)	V_c	m/min	45	45	45	45	45	45	45
	n	min ⁻¹	6000	4600	3800	3100	2300	1900	1600
	f_z	mm/tooth	0.0070	0.0098	0.0121	0.0158	0.0219	0.0275	0.0325
	V_f (peripheral)	mm	170	180	180	200	200	210	210
Alumium alloy, Copper alloy Carbon Steels, Alloy Steels Cast Irons EN-JL(GG), EN-JS (GGG) (-300HB)	V_c	m/min	80	80	80	80	80	80	80
	n	min ⁻¹	10600	8200	6700	5500	4100	3400	2800
	f_z	mm/tooth	0.0083	0.0116	0.0142	0.0186	0.0257	0.0323	0.0383
	V_f (peripheral)	mm	350	380	380	410	420	440	430

Please choose the cutting condition based on Tool diameter.



EDT-TH | Cutting Condition with Pilot Hole

$I_n 5 \times D_{Nom}$

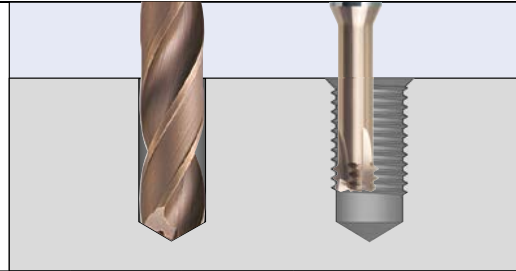

Standard with Pilot Hole (5 x D)									
Material group	Cutting Parameter	Thread	M3	M4	M5	M6	M8	M10	M12
		Pitch	0.5	0.7	0.8	1.0	1.25	1.5	1.75
		D mm	2.4	3.1	3.8	4.6	6.2	7.5	9
Pre-hardened steel (25–35HRC)	V_c	m/min	80	80	80	80	80	80	80
	n	min ⁻¹	10600	8200	6700	5500	4100	3400	2800
	f_z	mm/tooth	0.0093	0.0127	0.0153	0.0195	0.0263	0.0322	0.0382
	V_f (peripheral)	mm	400	420	410	430	430	440	430
Tool Steels (35–45HRC)	V_c	m/min	70	70	70	70	70	70	70
	n	min ⁻¹	9300	7200	5900	4800	3600	3000	2500
	f_z	mm/tooth	0.0088	0.0120	0.0145	0.0185	0.0249	0.0305	0.0361
	V_f (peripheral)	mm	330	350	340	350	360	370	360
Tool Steels (46–55HRC)	V_c	m/min	65	65	65	65	65	65	65
	n	min ⁻¹	8600	6700	5400	4500	3300	2800	2300
	f_z	mm/tooth	0.0083	0.0114	0.0137	0.0174	0.0235	0.0288	0.0341
	V_f (peripheral)	mm	290	300	290	310	310	320	310
Hardened Steel (56–62HRC)	V_c	m/min	55	55	55	55	55	55	55
	n	min ⁻¹	7300	5700	4600	3800	2800	2300	1900
	f_z	mm/tooth	0.0074	0.0100	0.0120	0.0154	0.0208	0.0254	0.0301
	V_f (peripheral)	mm	220	230	220	230	230	230	230
Hardened Steel and High speed steel (63–66HRC)	V_c	m/min	42	42	42	42	42	42	42
	n	min ⁻¹	5600	4300	3500	2900	2200	1800	1500
	f_z	mm/tooth	0.0064	0.0087	0.0104	0.0133	0.0180	0.0220	0.0261
	V_f (peripheral)	mm	140	150	150	150	160	160	160
Stainless Steel, Titan alloy (25–35HRC)	V_c	m/min	55	55	55	55	55	55	55
	n	min ⁻¹	7300	5700	4600	3800	2800	2300	1900
	f_z	mm/tooth	0.0079	0.0107	0.0129	0.0164	0.0221	0.0271	0.0321
	V_f (peripheral)	mm	230	240	240	250	250	250	240
Alumium alloy, Copper alloy Carbon Steels, Alloy Steels Cast Irons EN-JL(GG), EN-JS (GG) (-300HB)	V_c	m/min	95	95	95	95	95	95	95
	n	min ⁻¹	12600	9800	8000	6600	4900	4000	3400
	f_z	mm/tooth	0.0098	0.0134	0.0161	0.0205	0.0277	0.0339	0.0402
	V_f (peripheral)	mm	490	520	510	540	540	540	550

Please choose the cutting condition based on Tool diameter.

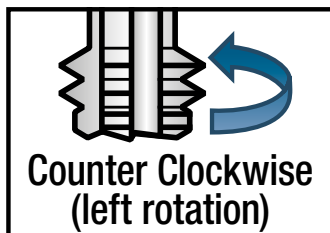

🇬🇧 NEVER forget counter clockwise rotation (M4), because EDT has left cutting edge!

🇮🇹 Attenzione: programmare la rotazione del mandrino sinistrorsa (M4), visto che le frese EDT hanno tagliente sinistro!

🇫🇷 Note : Assurez-vous d'avoir une rotation à gauche (antihoraire), l'EDT a une hélice à gauche !

🇩🇪 Achtung: Bitte stellen Sie den Linkslauf (M4) der Spindel sicher – EDT ist ein linksschneidendes Werkzeug!

🇪🇸 No olvide rotacion del cabezal a kizquierdas (M4), porque EDT tiene el filo de corte a izquierdas!

🇵🇹 Nota: Garanta rotação do eixo da árvore à esquerda porque o EDT tem arestas de corte esquerdas!



EDT-TH | Cutting Condition with Pilot Hole
G-Type (ISO 228-1)

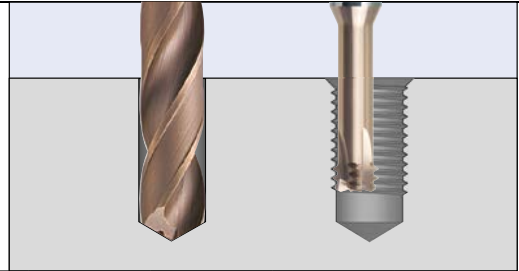

Standard with Pilot Hole (G-Type)									
Material group	Cutting Parameter		Thread	G 1/16-18	G 1/8-19	G 1/4-28	G 3/8-28	G 1/2-35	G 1-45
			Pitch	0.9071	0.9071	1.3368	1.3368	1.8143	2.3091
			D mm	5.8	7.3	9.8	11.8	15.7	15.8
Pre-hardened steel (25–35HRC)	V_c	m/min		85	85	85	85	85	85
	n	min ⁻¹		4700	3700	2800	2300	1700	1700
	f_z	mm/tooth		0.0280	0.0343	0.0406	0.0496	0.0632	0.0632
	V_f (peripheral)	mm		530	510	450	460	430	430
Tool Steels (35–45HRC)	V_c	m/min		75	75	75	75	75	75
	n	min ⁻¹		4100	3300	2400	2000	1500	1500
	f_z	mm/tooth		0.0265	0.0325	0.0385	0.0470	0.0599	0.0599
	V_f (peripheral)	mm		430	430	370	380	360	360
Tool Steels (46–55HRC)	V_c	m/min		65	65	65	65	65	65
	n	min ⁻¹		3600	2800	2100	1800	1300	1300
	f_z	mm/tooth		0.0250	0.0307	0.0363	0.0444	0.0565	0.0565
	V_f (peripheral)	mm		360	340	310	320	290	290
Hardened Steel (56–62HRC)	V_c	m/min		55	55	55	55	55	55
	n	min ⁻¹		3000	2400	1800	1500	1100	1100
	f_z	mm/tooth		0.0221	0.0271	0.0321	0.0392	0.0499	0.0499
	V_f (peripheral)	mm		270	260	230	240	220	220
Hardened Steel and High speed steel (63–66HRC)	V_c	m/min		45	45	45	45	45	45
	n	min ⁻¹		2500	2000	1500	1200	900	900
	f_z	mm/tooth		0.0191	0.0235	0.0278	0.0340	0.0432	0.0432
	V_f (peripheral)	mm		190	190	170	160	160	160
Stainless Steel, Titan alloy (25–35HRC)	V_c	m/min		55	55	55	55	55	55
	n	min ⁻¹		3000	2400	1800	1500	1100	1100
	f_z	mm/tooth		0.0236	0.0289	0.0342	0.0418	0.0532	0.0532
	V_f (peripheral)	mm		280	280	250	250	230	230
Alumium alloy, Copper alloy Carbon Steels, Alloy Steels Cast Irons EN-JL(GG), EN-JS (GGG) (-300HB)	V_c	m/min		95	95	95	95	95	95
	n	min ⁻¹		5200	4100	3100	2600	1900	1900
	f_z	mm/tooth		0.0295	0.0361	0.0428	0.0523	0.0665	0.0665
	V_f (peripheral)	mm		610	590	530	540	510	510

Please choose the cutting condition based on Tool diameter.

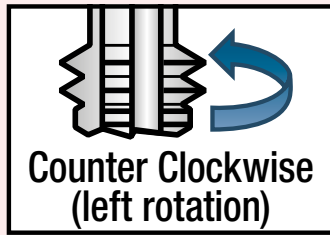
EDT-TH | Epoch Direct Thread Mill TH

🇬🇧 NEVER FORGET COUNTER CLOCKWISE ROTATION (M4), BECAUSE EDT HAS LEFT CUTTING EDGE!

Be careful of feed rate needed by programming (tool center feed rate or tool peripheral feed rate), when you need V_f center, please calculate by V_f center = V_f peripheral * (Thread Dia.-Tool Dia.) / Thread Dia.

Please choose coolant system which leads to better chip evacuation, for reference emulsion normally give better chip removal ability and air blow give longer tool life in hard material. For stainless material please use emulsion if possible.

🇩🇪 ACHTUNG: BITTE STELLEN SIE DEN LINKSLAUF (M4) DER SPINDEL SICHER – EDT IST EIN LINKSSCHNEIDENDES WERKZEUG!

Beachten Sie die erforderliche Vorschubrate bei der Programmierung (Vorschubrate des Werkzeug-Zentrums oder des Werkzeug-Umfangs). Um V_f [Wkz.-Zentrum] zu erhalten, berechnen Sie bitte: V_f [Wkz.-Zentrum] = V_f [Wkz.-Umfang] · (D Gewinde - D Wkz.) / D Gewinde.

Bitte wählen Sie die Kühlmethode mit der bestmöglichen Späneabfuhr: Kühlung mit Emulsion verbessert die Späneabfuhr, während Luftkühlung die Lebensdauer des Werkzeugs bei harten Materialien verlängert. Für die Bearbeitung rostfreier Materialien bitte möglichst Kühlemlulsion verwenden.

🇮🇹 ATTENZIONE: PROGRAMMARE LA ROTAZIONE DEL MANDRINO SINISTRORSA (M4), VISTO CHE LE FRESE EDT HANNO TAGLIANTE SINISTRO!

Fare attenzione alla velocità di avanzamento nella programmazione (Avanzamento al centro dell' utensile o Avanzamento periferico). In caso si necessiti di avanzamento rispetto al centro calcolare l'avanzamento stesso (V_f), come segue: V_f centro = V_f periferico * (Diametro Filetto - Diametro Utensile) / Diametro Filetto.

Si prega di scegliere il sistema refrigerante che garantisce la migliore evacuazione dei trucioli trucioli, l' emulsione di solito garantisce una migliore capacità di asportazione mentre l'aria garantisce una maggiore vita utensile con materiali ad alta durezza. Per materiali inossidabili si raccomanda l'utilizzo di emulsione.

🇪🇸 NO OLVIDE ROTACION DEL CABEZAL A IZQUIERDAS (M4), PORQUE EDT TIENE EL FILO DE CORTE A IZQUIERDAS!

Tenga cuidado al establecer el avance en el programa (Avance al centro de la herramienta o Avance periférico). Si necesita determinar el V_f al centro calcúlelo por favor en base a V_f al centro = V_f periférico * (diámetro rosca - diámetro herramienta) / diámetro rosca.

Por favor, elija el sistema de refrigeración que permite una mejor evacuación de viruta. Un sistema con taladrina proporciona mejor evacuación de viruta. Un sistema con aire soplado proporciona más vida en materiales duros. Para aceros inoxidables, por favor utilice taladrina si es posible.

🇫🇷 NE JAMAIS OUBLIER LA ROTATION BROCHE ANTIHORAIRE (M4), L'EDT A UNE HÉLICE À GAUCHE !

Faites attention au type d'avance nécessaire à la programmation (avance au centre de l'outils ou avance périphérique), pour calculer l'avance au centre outil, procéder de la façon suivante : V_f périphérique * (Diamètre taraudage - Diamètre outil) / Diamètre taraudage

Veillez choisir la lubrification la plus efficace en termes d'évacuation des copeaux. À titre indicatif, l'émulsion soluble permet une meilleure évacuation des copeaux et le soufflage d'air donne une meilleure durée de vie dans les matériaux durs. Pour les inoxydables, utiliser de l'émulsion, si possible.

🇵🇹 NOTA: GARANTA ROTAÇÃO DO EIXO DA ÁRVORE À ESQUERDA PORQUE O EDT TEM ARESTAS DE CORTE ESQUERDAS!

Esteja atento ao avanço necessário pela programação (avanço central ou avanço periférico), quando necessitar de V_f Central, calcule com V_f Central = V_f periférico * (Thread Diâmetro - Diâmetro da ferramenta) / Diâmetro Thread.

Selecione um sistema de refrigeração que gere melhor remoção de aparas - para referência, normalmente a emulsão confere melhor capacidade de remoção das aparas e o sopro de ar confere melhor tempo de vida útil de ferramenta em metal duro. Para material inoxidável utilize emulsão sempre que possível.

Always up to date: Please check our P50 QuickFinder



Product Range

Solid Carbide End Mills



Indexable Milling Tools



WHNSB Drills



Milling Chucks



Distributed by:

MMC Hitachi Tool Engineering Europe GmbH

Itterpark 12 · 40724 Hilden · Germany · Phone +49 (0) 21 03-24 82-0 · Fax +49 (0) 21 03-24 82-30
E-Mail info@mmc-hitachitool-eu.com · Internet www.mmc-hitachitool-eu.com
© 2018 by MMC Hitachi Tool Engineering Europe GmbH · 3rd Edition · Printed in Germany